



IMMINENT AND SIGNIFICANT CHANGES TO HORIZONTAL AND VERTICAL DATUMS AND COORDINATE SYSTEMS IN THE UNITED STATES

WHAT YOU NEED TO KNOW

Presented by Frank Borges, PLS
Towill, Inc.

CMANC 2023 Fall Meeting
Sacramento, CA



TRIVIA !!!



TRIVIA !!!

As measured from the center of the earth,
what is the tallest mountain?

MT. CHIMBORAZO

ECUADOR

The summit is over 6800 feet further from the center of the earth than Mt. Everest



Earth's shape is an ellipsoid

- 13 miles shorter along semi-minor axis
- 'Flattening Factor' of $1/298.25 \pm$

But why is this important?????

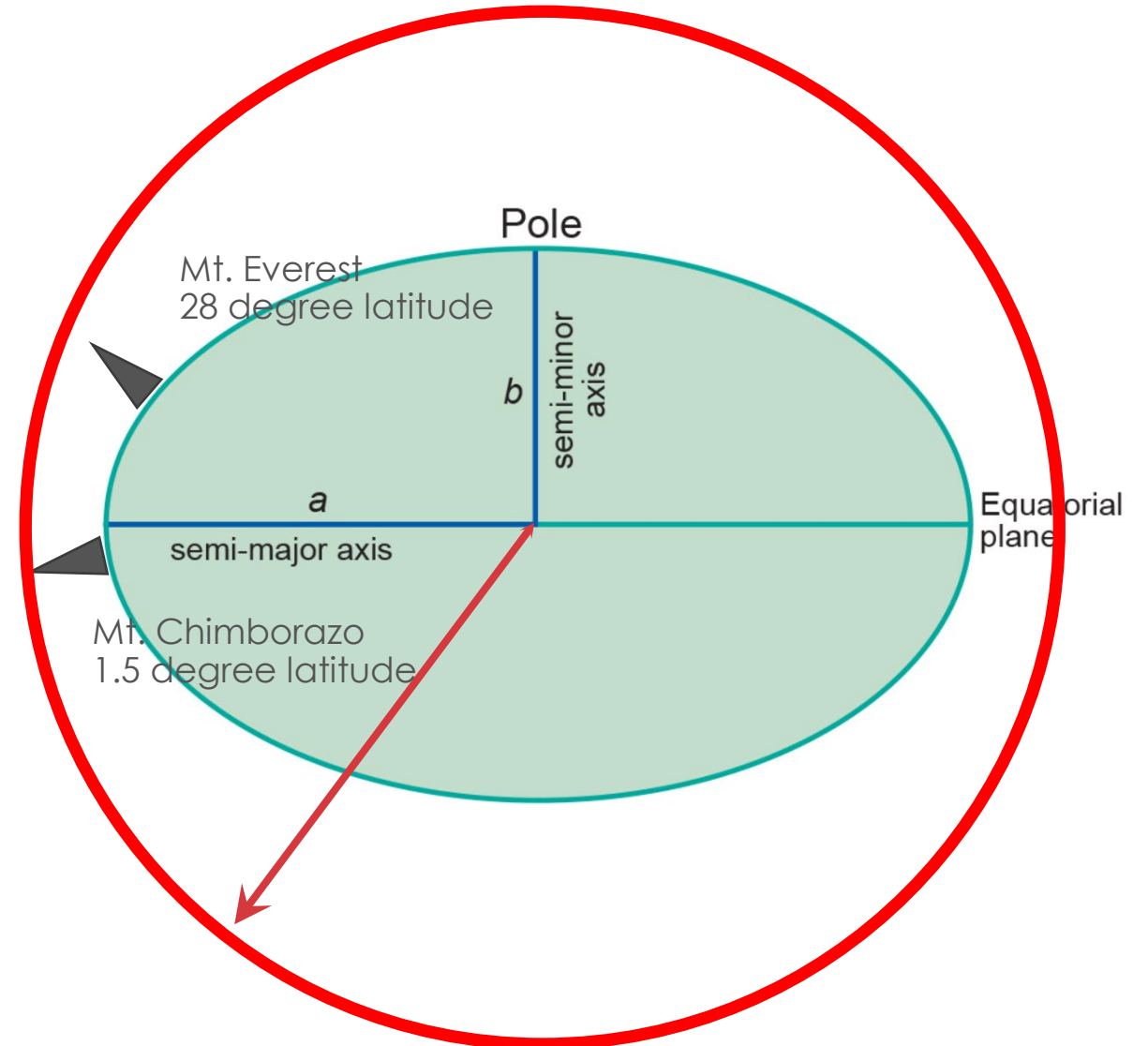

BUT WHY IS THIS IMPORTANT????

- Geospatially correct data is critical for U.S. interests
 - Military
 - Federal Government
 - Civilian
 - Infrastructure (e.g. coastal, levees, highways)
- We are becoming more and more reliant on geospatially correct data



VOCABULARY



Geodesy: *the branch of mathematics dealing with the shape and area of the earth or large portions of it.*

Geodesist: *measure and monitor the Earth to determine the exact coordinates of any point. Geodesists measure and monitor the Earth's size and shape, geodynamic phenomena (e.g., tides and polar motion), and gravity field to determine the exact coordinates of any point on Earth and how that point will move over time.*



GNSS: *Global Navigation Satellite System.*
Includes GPS (U.S.), Galileo (EU),
BeiDou (China), and GLONASS (Russia)

NSRS: *The National Spatial Reference System is*
a consistent coordinate system that defines
latitude, longitude, height, scale, gravity, and
orientation throughout the United States.

Datum: *the thing that this presentation is really*
about...that's more complicated

WHAT IS A DATUM?

- What is the elevation of "A"?

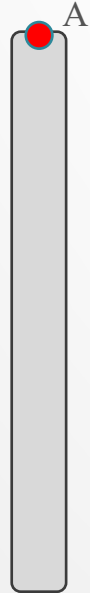

WHAT IS A DATUM?

- What is the elevation of "A"?

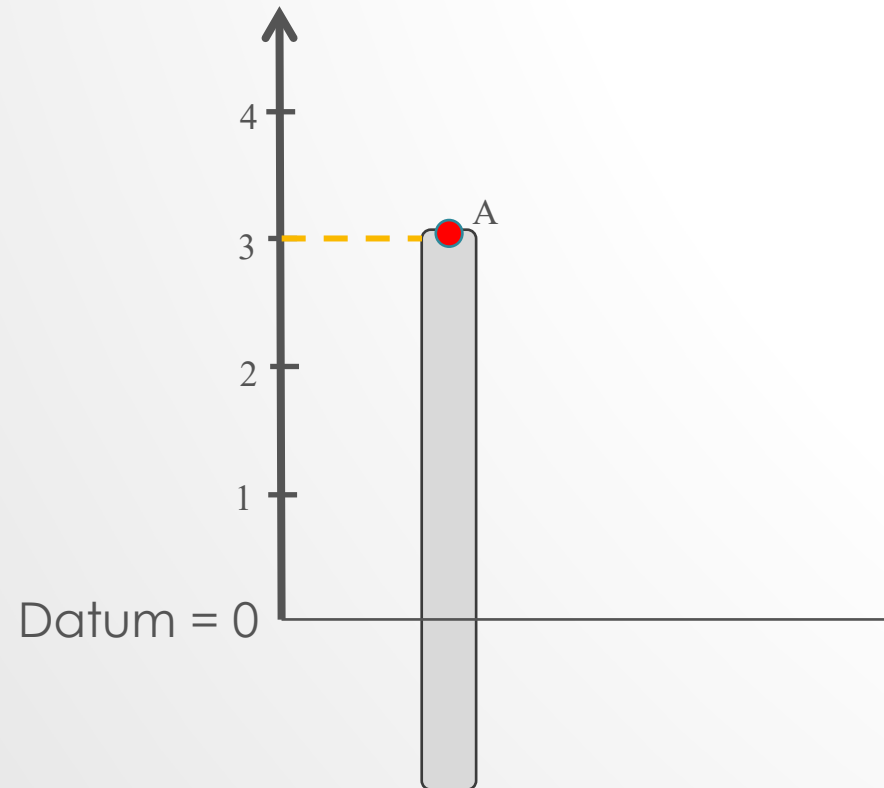

WHAT IS A DATUM?

- What is the elevation of "A"?

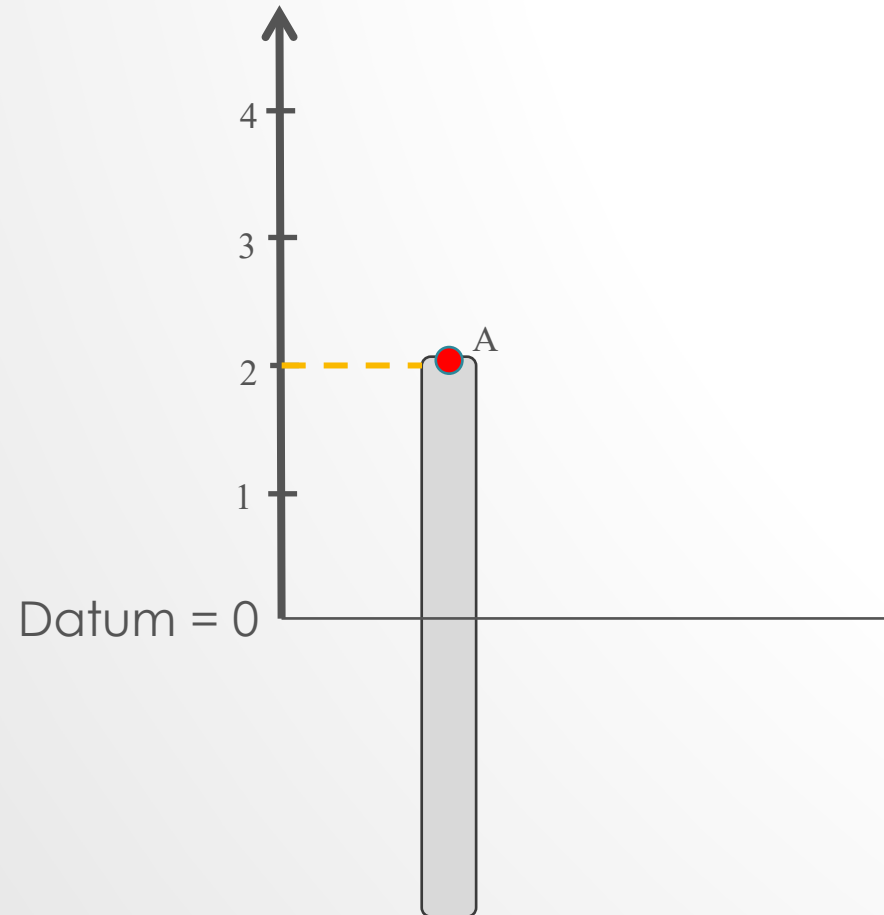

WHAT IS A DATUM?

- The same can be said for coordinate positions

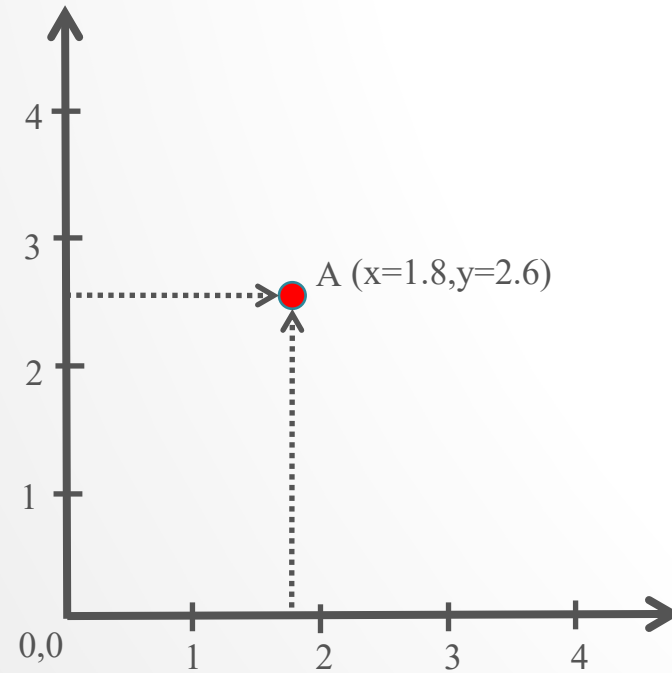

WHAT IS A DATUM?

- The same can be said for coordinate positions

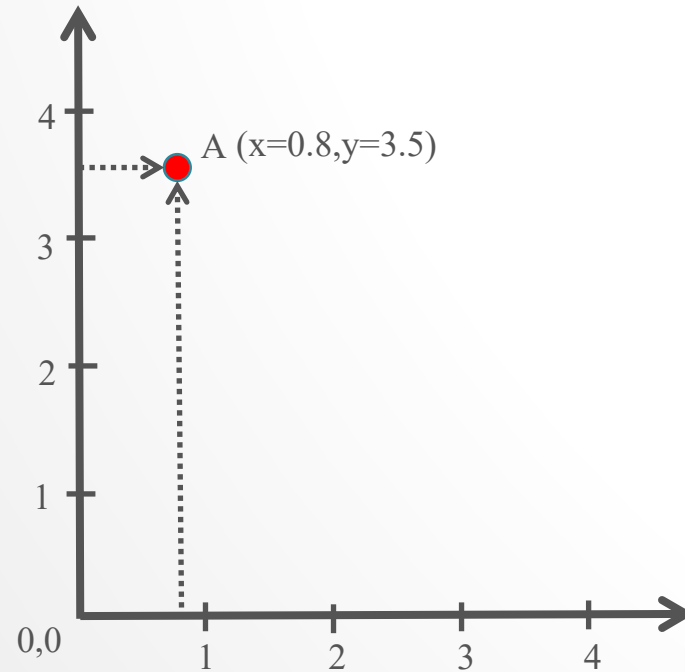

WHAT IS A DATUM?

- The same can be said for geographic coordinates

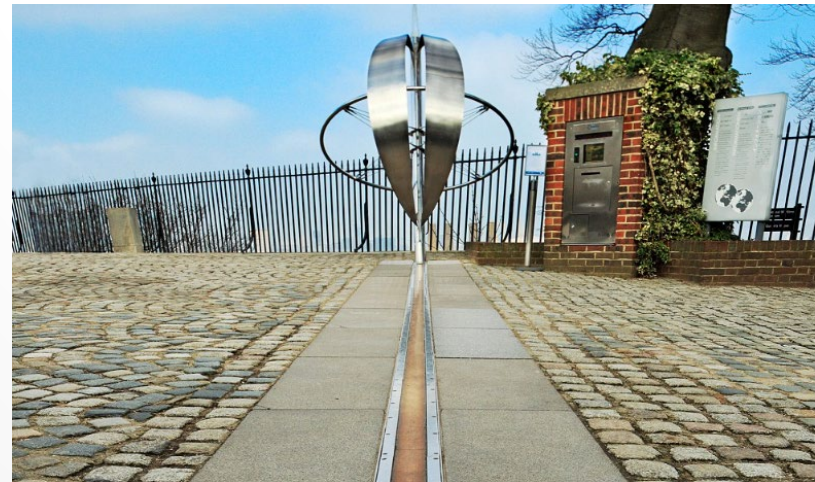
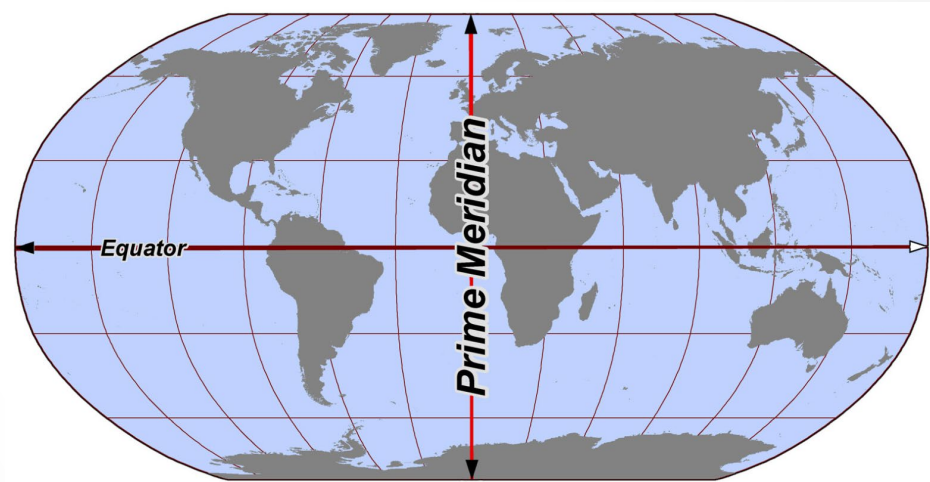

TRANSITIONING TO A MODERN NSRS

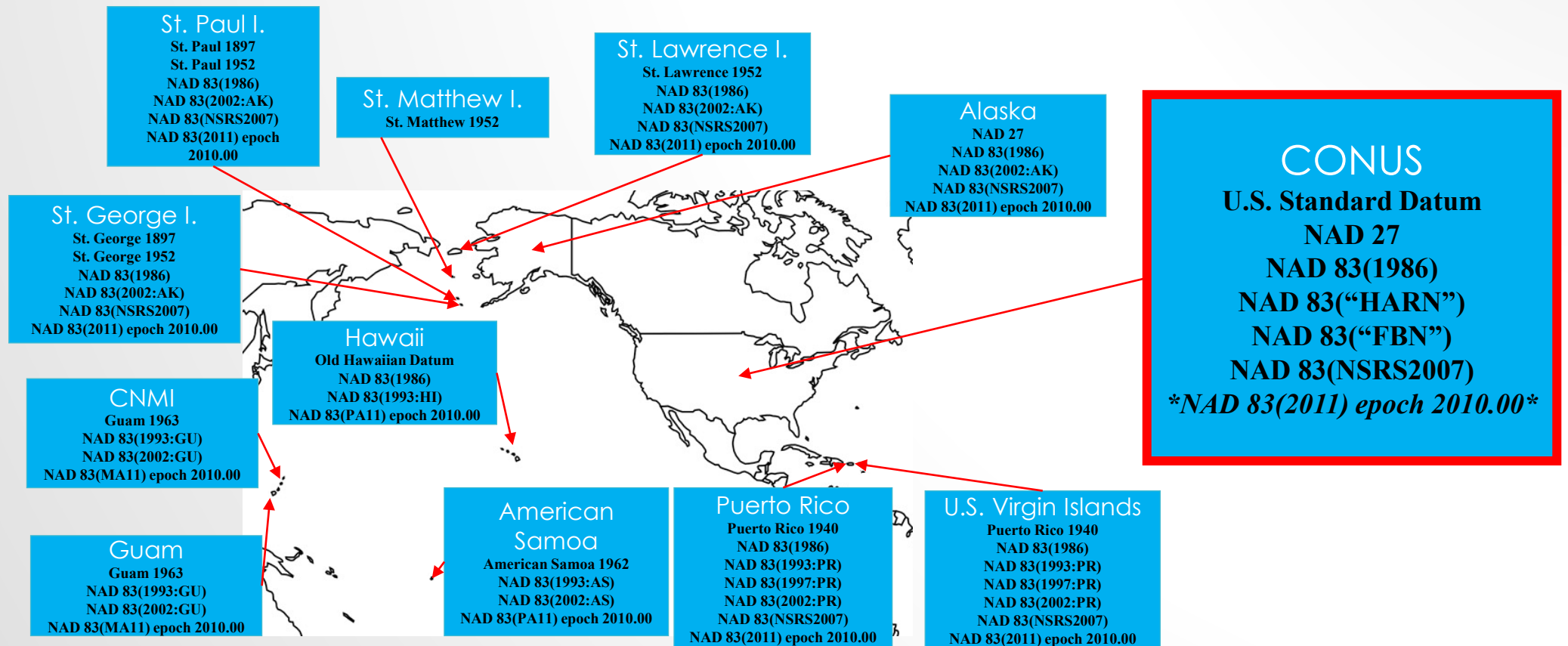

TRANSITIONING TO A MODERN NSRS

- The current NSRS was:
 - Defined in the pre-GPS era
 - Without GPS, the Earth's center (frame origin) was very hard to detect
 - Defined without aid of gravity-mission satellites
 - Leveling, terrestrial gravity, disconnected from the geometric frame
- Defined right after punch-cards went away
 - Tools relied upon 80-character ASCII files and FORTRAN
- Defined without a long-term strategy to acknowledge Earth's dynamics
- In short, the current NSRS has failed to keep up with emerging needs
 - Sea level rise, floodplain mapping

THE UPCOMING NSRS

- **NATRF2022** - The North American Terrestrial Reference Frame of 2022
- Replacing NAD83 – The North American Datum of 1983
- Horizontal shift of 1 to 1.5m in California (3 - 4.5 ft)
- Time component

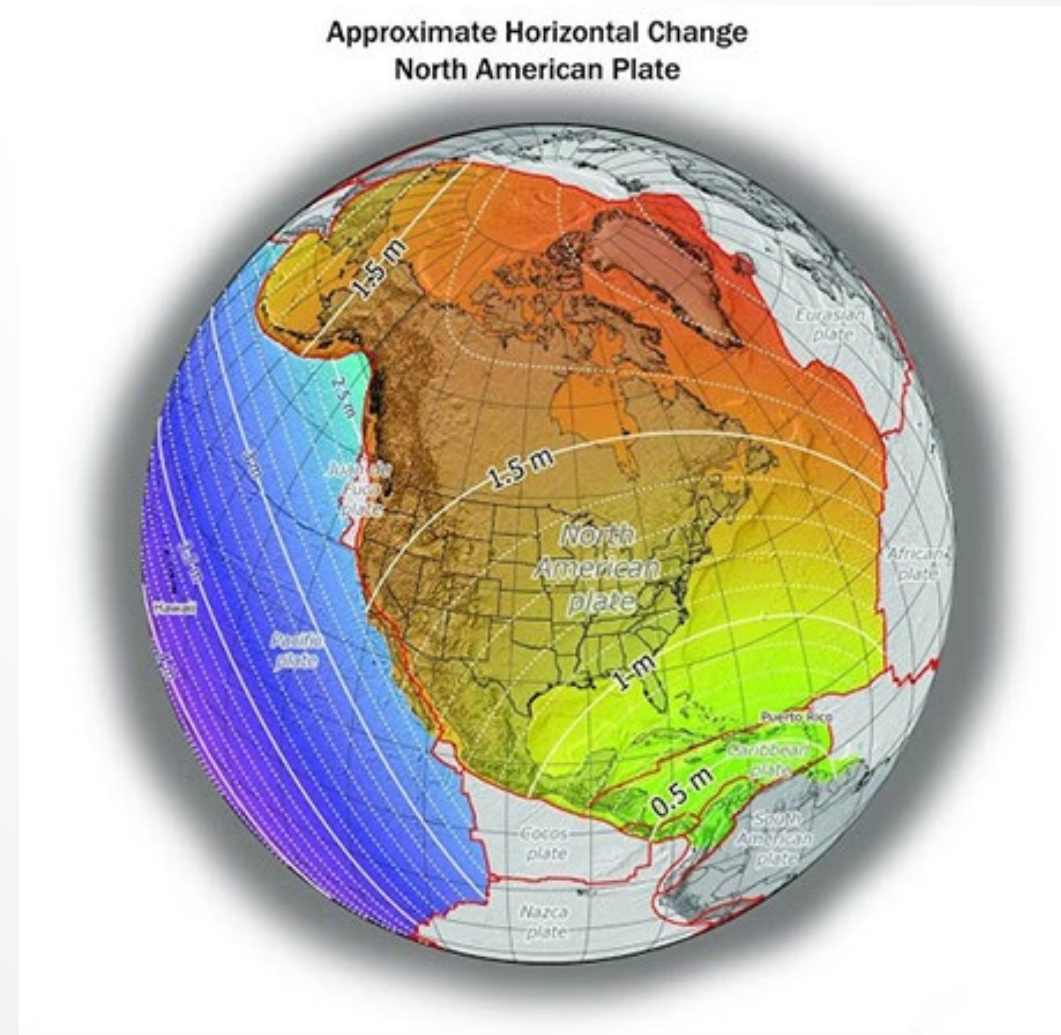

THE UPCOMING NSRS

- Updating State Plane Coordinates
- Projecting a flat surface onto an ellipsoid is complicated!!

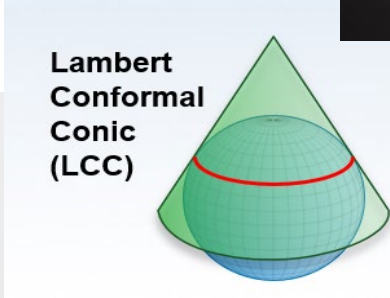
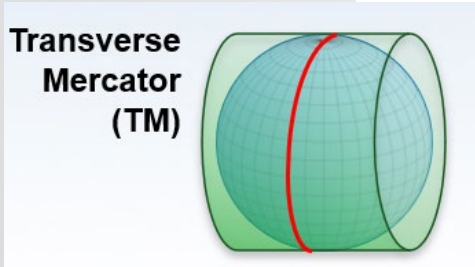
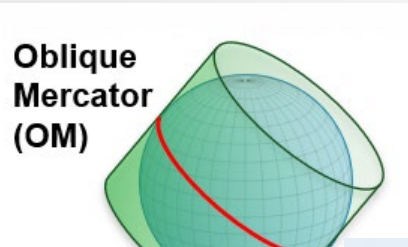

How surveyors and engineers see the Earth...

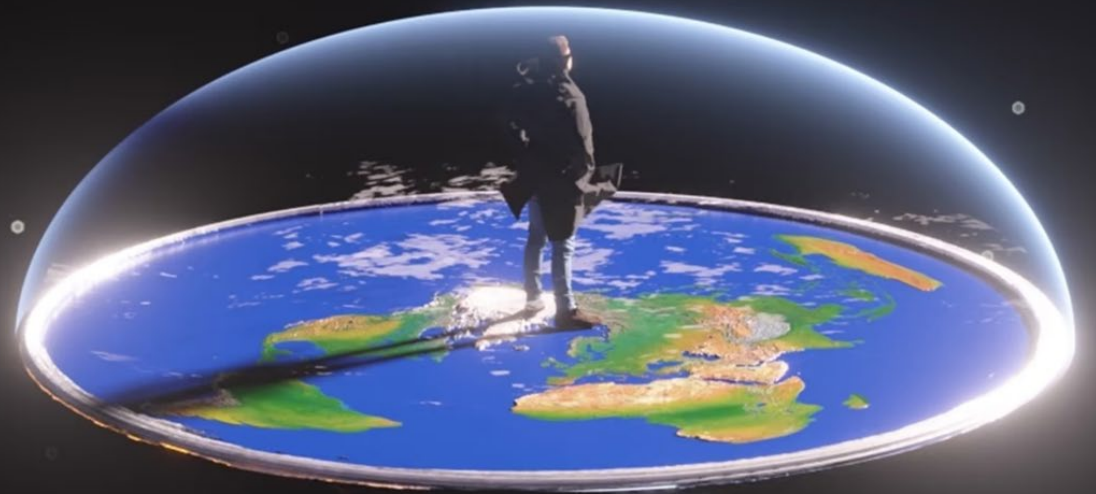

THE UPCOMING NSRS

- State Plane Coordinate System of 2022
- Based on the new terrestrial reference frame (NATRF2022)
- Low Distortion Projections (LDPs)
 - Minimize distortion from 'grid to ground', terrain
 - Also took into account population density
- Input by State stakeholders

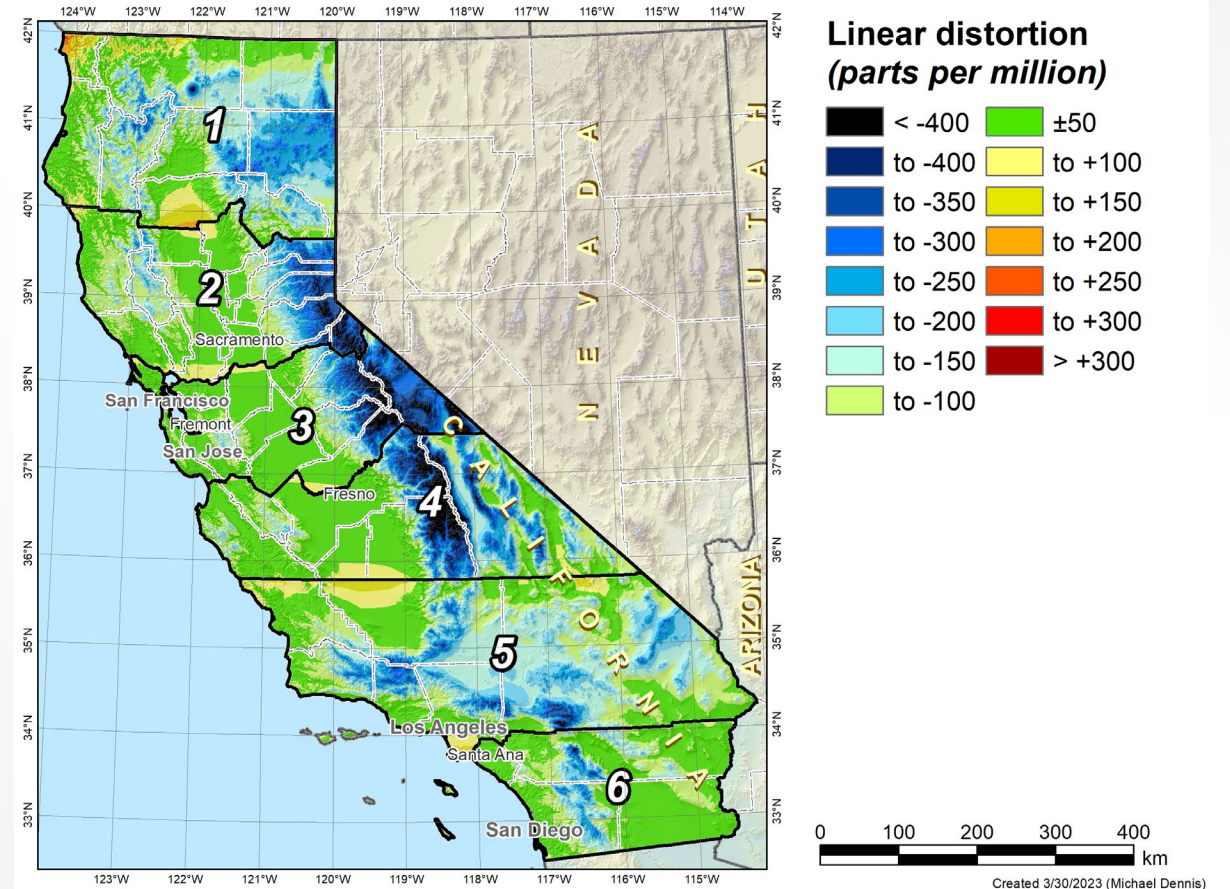

THE UPCOMING NSRS

- New Vertical Datum
- **NAPGD2022** - The North American-Pacific Geopotential Datum of 2022
- Replacing NAVD88 – The North American Vertical Datum of 1988
- Differences between 0.5m (1.6 ft) to 1 m (3.3 ft) in California

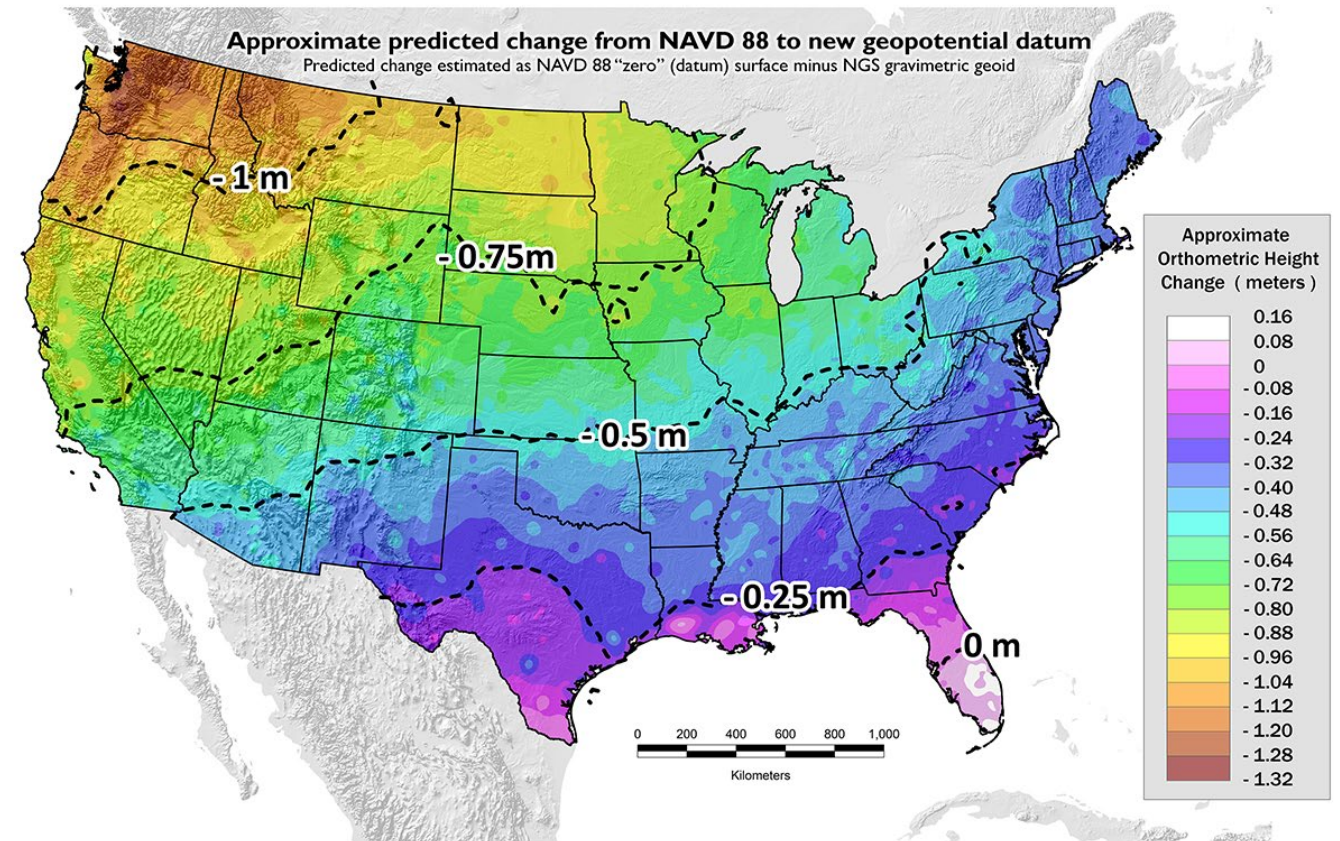

THE UPCOMING NSRS

- U.S. survey foot was officially deprecated on December 31, 2022
- NGS will support U.S. Survey Feet on old Datums, but not new datums
- International foot to be used moving forward
 - $1\text{m} = 3937/1200$ U.S. Survey Feet
 - $1\text{m} = 3.2808$ International Feet
 - Difference is about one inch in 1.5 miles

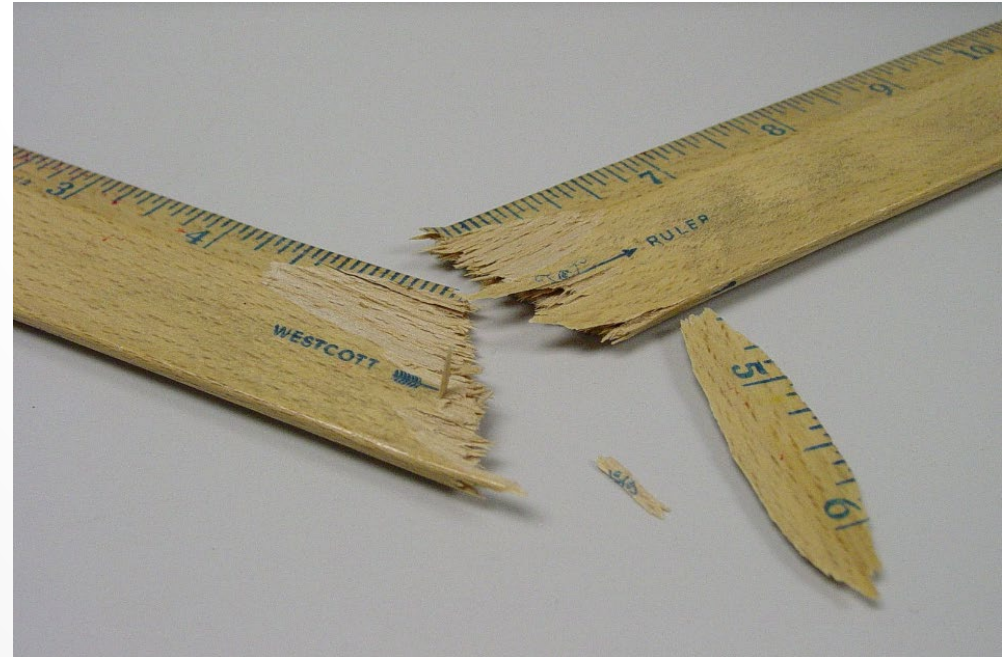

THE UPCOMING NSRS

- Terminology change:
“ELEVATION” will be replaced with
“ORTHOMETRIC HEIGHT”
- Satellite-based definition of Datums, shift away from monuments



IMPORTANT TAKE-AWAYS

- Big changes are coming to horizontal and vertical datums and coordinate systems in the United States
- New vertical datum (NAPGD2022) is coming, will be different from NAVD88 by 0.5m (1.6 ft) to 1 m (3.3 ft) in California
- When is it coming? Last update is 2025.
- New long-term projects: there are ways one can 'future-proof' to help projects bridge from old to new datums.
- This is a very basic overview of what is expected. Reach out with any questions.



THANK YOU!

Credits-

- Presentation: Tidbits and Progress Towards Modernizing the National Spatial Reference System; March 26, 2023; Dana J. Caccamise II, PhD and Michael L. Dennis, PhD, PE, PLS
- Presentation: Datums - The Foundation of Geospatial Data; January 26, 2023; Jacob Heck, Ph.D., P.S.
- Website: www.ngs.noaa.gov
- Trevor Greening of Towill, Inc.